

FXLuminaire.

LX SERIES TRANSFORMER

Digital control lighting transformer



**Instruction Manual for the
LX150 and LX300
Gen2**

TABLE OF CONTENTS

FX LUMINAIRE SERIES TRANSFORMER COMPONENTS	4
INDICATOR LIGHT MEANINGS.....	4
LCD SCREEN SYMBOL GUIDE.....	5
INSTALLING THE TRANSFORMER	6
STEP 1 – LOCATING THE TRANSFORMER.....	6
STEP 2 – MOUNTING TRANSFORMERS.....	7
STEP 3 – RUNNING CABLE TO THE FIXTURES.....	9
SUMMARY.....	10
CIRCUITING GUIDELINES	11
CABLE STATS.....	11
CABLING METHODS.....	12
GENERAL NOTES	13
CONNECTING CABLES AT THE TERMINAL BLOCK.....	13
INSTALLATION TOOLS	14
RECEPTACLE TESTER.....	14
DIGITAL VOLTMETER.....	14
THE AMP CLAMP.....	15
SYSTEM MAINTENANCE	17
USING PROGRAMMING FUNCTIONS	18
INSTALLING MULTIPLE TRANSFORMERS	20
FREQUENTLY ASKED QUESTIONS	21
GLOSSARY	22
TROUBLESHOOTING	23
IMPORTANT NOTES	24
WARRANTY	25
NOTES	26

FX LUMINAIRE SERIES TRANSFORMER COMPONENTS

INDICATOR LIGHT MEANINGS

LEFT ROW

AUTO – Program is running

SET TIME – Set current time and day

ON TIME – Set time for light initiation by time and day for each Program (A-F)

OFF TIME – Set time for lights off by time and day for each Program (A-F)

MANUAL – Set duration of lights on manual mode

OFF – System off (3 seconds before initiates)

BOTTOM ROW

120VAC in – Green Indicates Powered Unit and incoming voltage is 108V or above. Red indicates incoming voltage is below 108V.

EXT IN – Green indicates when a signal is received on the EXT IN port from 1-24V that has caused the lights to initiate.

PHOTOCELL – Green indicates luminaires ON due to photocell

12V OUT – GREEN: Controller sending power to luminaires
RED: Overload detected











CONTROL BUTTONS

1. MODE SELECTOR – Center under LCD
2. ARROW UP AND DOWN – Increases value or decreases value
3. ENTER BUTTON – Right Center to LCD



FX LUMINAIRE SERIES TRANSFORMER COMPONENTS

LCD SCREEN SYMBOL GUIDE

	Indicates dawn setting		System is detecting daylight
	Indicates dusk setting		System is detecting nighttime or lack of light
	Indicates the time of day, start or stop time. In manual mode indicates the remaining duration		Photocell not installed
	During setting, indicates the ON TIME function		Indicates electrical load being used by system (each bar represents 10%)
	During setting, indicates the OFF TIME function	EXT	Indicates that the EXT input is active
	System is operating in manual (owner-operated) mode		Indicates Lights and Program are running

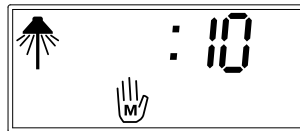
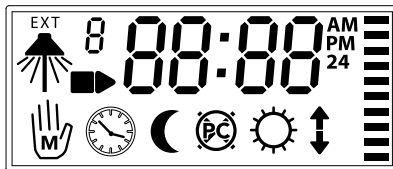

MANUAL

INSTALLING THE TRANSFORMER

STEP 1 – LOCATING THE TRANSFORMER

Locate transformer(s) in a well-ventilated area away from direct irrigation spray and central to where the majority of the lighting fixtures will be installed. The goal is to minimize the length of cable runs from your transformer to the lighting fixtures thus minimizing voltage drop and cable size.

Transformer(s) with power cords must be located adjacent to a 120 volt GFCI protected exterior electrical receptacle. If a 120 volt power source is not available at the desired transformer installation location, it is advised that you hire a licensed electrician to run a dedicated 120 volt, 15 amp circuit to the desired location.

Test all existing receptacles with both a receptacle tester and a digital voltmeter or amp clamp to verify proper wiring and voltage at the receptacle.

SINGLE TRANSFORMER

When using only one transformer, it is very important to center the transformer on the wattage load. If the project calls for 75 watts in both front and back yard, the LX Series Transformer should be centered on the side of the house that will receive the most lighting. A common mistake is to locate the single transformer on the service side of the house or in the garage, which might result in excessively long cable runs to reach lighted areas. The primary goal in laying out low voltage systems is to minimize cable runs because of voltage.

MULTIPLE TRANSFORMERS

A common mistake in connecting multiple transformer circuits is to group several transformers in one location because of utility or visual considerations only. As with any low voltage layout, the prime directive should be to locate the transformers as close to the fixtures as possible in order to minimize cable runs and resulting voltage drop. The other multi-transformer layout consideration is “use zoning.” Having several transformers allows the client to selectively control light in separate areas. This approach is similar to irrigation design in that the goal is to individually control areas that have similar needs. In lighting, a recreation area has different lighting needs than front entry. Therefore, the lights that serve these different lighting use areas need to be on separate transformers and switch controls.

INSTALLING THE TRANSFORMER

STEP 2 – MOUNTING TRANSFORMERS

WALL MOUNT

By code, all transformers must be installed a minimum of 12" above finish grade as measured from finish grade to the bottom of the transformer. Mark top anchor location on wall, drill pilot hole, insert anchor and install screw into anchor leaving approximately 1/8" of thread exposed on the screw. Mount transformer on screw.

Mark locations for bottom anchors with permanent marker. Remove transformer from wall. Drill bottom anchor holes and install anchors. Place transformer back on top of anchors and install screw(s) into anchors at bottom of transformer to secure it to the wall.

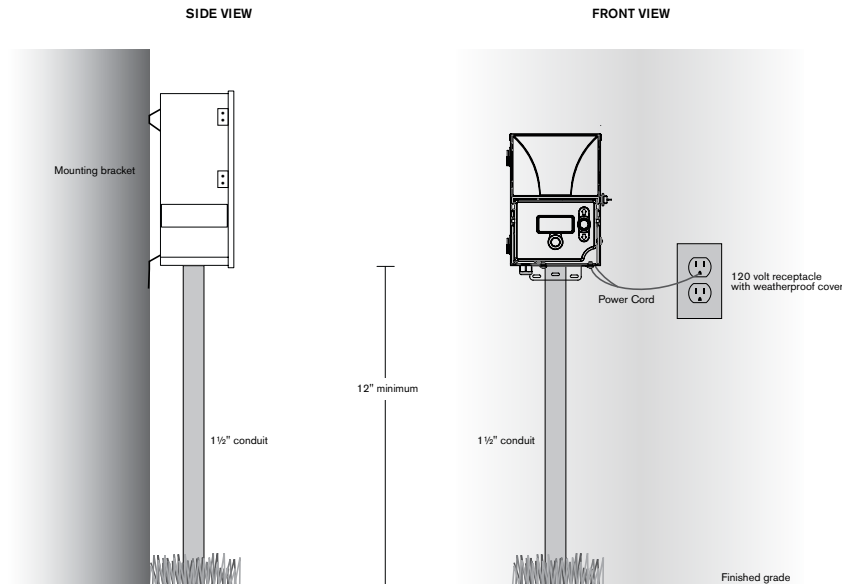

INSTALLING THE TRANSFORMER

STEP 2 – MOUNTING TRANSFORMERS (CONT.)

POST MOUNT INSTALLATION

Install pressure treated 4" x 4" x 36" (min) post in concrete footing. Install single anchor screw 1 1/2"– 2" below the top of post. Place transformer on screw. Place 9" torpedo level on top of transformer and level transformer. Once level, secure transformer to post by installing 1 or 2 screws on the bottom-mounting bracket.

For additional information regarding installation techniques, visit www.fx.com, and click on Learning Center.

All LX Series Transformers come equipped with a 3 foot, 12 gauge, 3-prong electrical power cord to be used in conjunction with a 120 volt class A type ground fault circuit interrupter electrical receptacle. The LX power cord should be used only in conjunction with a 120 volt receptacle. Do not use an extension cord with a cord connected landscape lighting system.

For hard wire installations, remove the LX power cord and wire the transformer in compliance with local electrical building codes. It is recommended that the electrician install a dedicated 15 or 20 amp circuit breaker in the electrical panel.

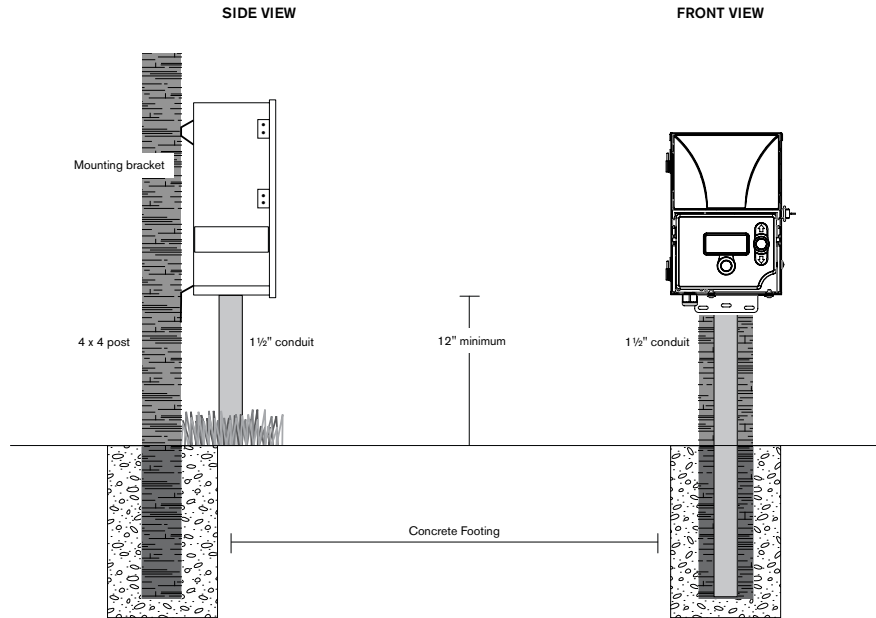

INSTALLING THE TRANSFORMER

STEP 3 – RUNNING CABLE TO THE FIXTURES

Once the transformer has been installed and all fixture locations determined, the next step is to run the correct size cable from the transformer to the fixtures while providing each fixture with between a 10.5 and 11.5 volt operating range. LED fixtures should be provided between 10 and 15 volts. This is accomplished by:

1. Grouping fixtures into distance zones as illustrated below. Do not have a fixture that is 10' away from the transformer on the same cable run as one that is 100' away.
2. Use the proper cabling method for the application. Try to center load all cable runs when possible to minimize the voltage differential between fixtures. Maximum voltage differential between the first fixture and the last fixture on any given circuit should not exceed 1 volt with a 0.5 volt differential being optimum.
3. LED fixtures can vary in voltage and will all be the same brightness as long as between 10 and 15 volts is being supplied to each fixture.

4. Use the correct size cable to accommodate voltage drop. As a general rule of thumb, limit the wattage load per each cable run to no more than 100 to 160 watts.

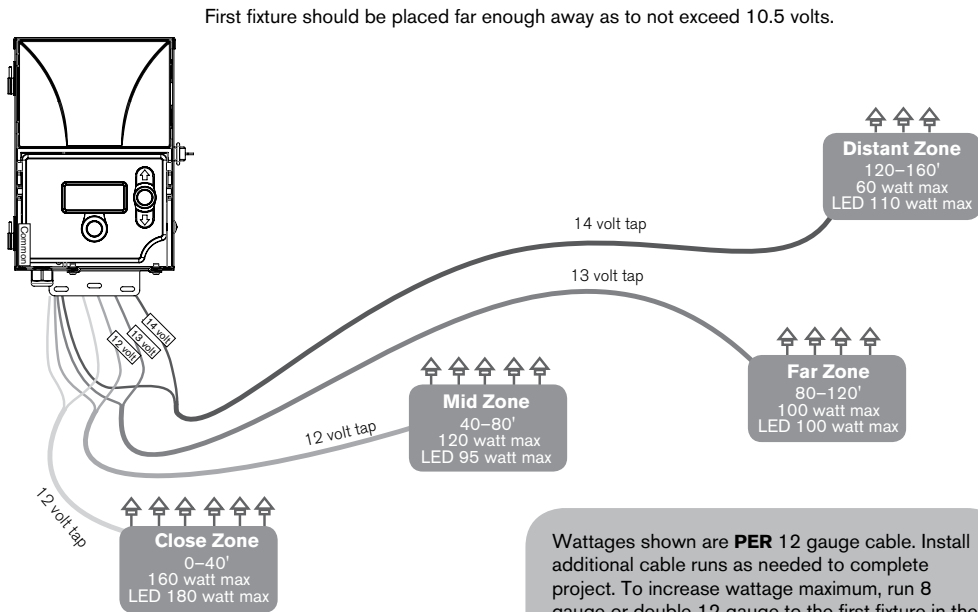

INSTALLING THE TRANSFORMER

SUMMARY

For maximum light output and lamp life, the goal when installing low voltage systems is to provide each lamp with between 10.5 and 11.5 volts and LED with 10 to 15 volts. To stay within a 0.5 to 1.0 volt differential between the first light and the last light on a given circuit (while LED lights can support several volts of difference, good design practice is to minimize the voltage difference), you must group the fixtures into distance zones and not overload the cable with excessive wattage. As a rule of thumb, limit the distance between the first fixture and the last fixture on any given run to no more than 50 feet.

The FX MultiTap Transformer allows you the opportunity to utilize the voltage tap that will provide each circuit with the proper voltage. For cable runs in the “distant zone” you would typically select the 13 or 14 volt tap. For cable runs in the “close zone,” you would typically install the cable run into the 12 volt tap depending upon the wattage load and size of cable.

CIRCUITING GUIDELINES

CABLE STATS

Low voltage lighting systems are typically installed using UF (underground feeder) rated stranded cable. The most common cable used is referred to as 12/2 stranded cable. The size of cable used in wiring the lighting system will be determined by the wattage load and length of cable run from the transformer to the lighting fixtures.

It is very important to note that all low voltage cable has a maximum safe rating. Overloading cable can create a dangerous safety hazard so be sure to cable your lighting system with the proper size cable.

LOW VOLTAGE CABLE

Each low voltage lighting cable consists of two parts. One part of the cable is designated to carry the voltage load and is referred to as the "hot" lead. The "hot" section is installed into one of the low volt "hot" lugs on the terminal block. The other section is referred to as the "common" lead and is installed into the lugs labeled "common." Voltage is carried out from the transformer to the fixtures via the "hot" side of the cable and returns back to the transformer "common" tap via the other half of the cable thus completing the circuit.

**LOADS
PER CABLE**

*Add cable runs
as necessary*

Close-Zone 0-40'
12 Gauge 160 watts max. 10 Gauge 180 watts max. 8 Gauge 220 watts max.

Mid-Zone 40-80'
12 Gauge 120 watts max. 10 Gauge 140 watts max. 8 Gauge 200 watts max.

Far-Zone 80-120'
12 Gauge 100 watts max. 10 Gauge 120 watts max. 8 Gauge 180 watts max.

Distant-Zone 120-160'
12 Gauge 60 watts max. 10 Gauge 100 watts max. 8 Gauge 160 watts max.

**LED
LOADS
PER CABLE**

*Add cable runs
as necessary*

For maximum
efficiency,
input voltage
to LED should
be between 10
and 15 volts.

Close-Zone 0-40' using voltage tap 12
14 Gauge 115 watts max. 12 Gauge 180 watts max. 10 Gauge 300 watts max.

Mid-Zone 40-80' using voltage tap 12
12 Gauge 95 watts max. 10 Gauge 150 watts max.

Far-Zone 80-120' using voltage tap 13
12 Gauge 100 watts max. 10 Gauge 160 watts max.

Out There-Zone 120-160' using voltage tap 14
12 Gauge 110 watts max. 10 Gauge 175 watts max.

CIRCUITING GUIDELINES

CABLING METHODS

Within each cabling zone, you may utilize any of a number of cabling methods. The primary objective is to minimize voltage drop by installing the proper size feeder cable (home run) to each zone and to make sure that each fixture on each cable run is receiving between 10.5 and 11.5 volts, or 10–15 volts for LED fixtures. Center feeding the “home run” (the main cable run from the transformer to the first fixture on the circuit) will help minimize the voltage differential between the first fixture and the last fixture on the cable run.

DAISY CHAIN METHOD (RECOMMENDED FOR LED SYSTEMS)

Daisy chained circuits are the least efficient cabling method as more voltage is fed to the first fixture on the run and due to voltage drop, each subsequent fixture receives less and less voltage. This is not a problem for FX LED fixtures due to its large voltage acceptance range of 10–15 volts.



TEE METHOD

The tee method center feeds the “home run” section of the cable and reduces the voltage differential between the first fixture and the last fixture on either side of the “tee.” This method is the preferred circuiting technique as it is easy to install and minimizes the voltage drop between first and last fixtures.

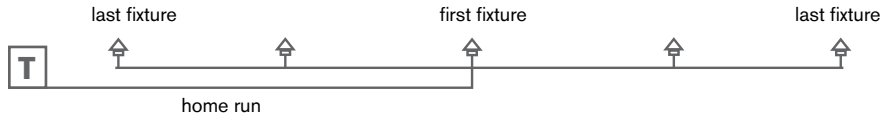

GENERAL NOTES

CONNECTING CABLES AT THE TERMINAL BLOCK

TRANSFORMER TERMINAL BLOCK

The LX Series Transformer includes one “common” lug, and three “hot” lugs. Four smaller lugs are located on left side of the voltage lugs, which provide a connection for an External Transformer Signal of 12-24 volts and two connections for the proprietary low voltage Photocell unit.

COMMON LUGS

One conductor from each cable run coming from the lights to the transformer must be connected to one of the common lugs. The other conductor will be installed into the hot lug that provides the optimum voltage for each circuit.

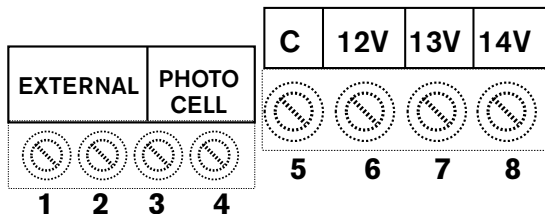

CHOOSING THE PROPER “HOT” VOLTAGE LUG

Choosing the proper “hot” voltage lug in which to install the conductor is determined by the circuit’s voltage drop. If a circuit’s voltage drop is calculated to be about 3 volts, install the “hot” side of the cable into the 14 volt tap to assure proper voltage at the lamp (14 volts minus 3 volts = 11 volts). The voltage reading at each “hot” lug will vary depending upon the incoming voltage provided by the 120 volt receptacle. If the receptacle reads 128 volts, it is not uncommon for the 12 volt lug on the transformer to read 12.6–12.9 volts. On the other hand, if the receptacle is reading only 116 volts, the 12 volt lug may only read 11.8–12.2 volts. Always verify both high voltage and low voltage readings with a digital voltmeter. Fine-tune each circuit by using a digital voltmeter. Lamps perform best when supplied between 10.5 and 11.5 volts. Before waterproofing wire connections, take a voltage reading at the first and last fixture on each circuit. If the voltage reading at the first fixture on the circuit reads less than 10.5 volts, move the conductor up to a lug that will provide approximately 11 to 11.5 volts. LED fixtures should be provided between 10 and 15 volts.

INSTALLATION TOOLS

RECEPTACLE TESTER

This tool tells you whether or not the 120 volt receptacle you are plugging the LX Series Transformer into is wired properly. Follow the tool manufacturers instruction manual to assure proper wiring on the receptacle you will be using.

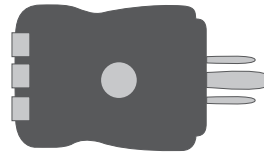

DIGITAL VOLTMETER

This tool allows you to take important voltage readings at the transformer, at each fixture and at the receptacle the transformer will be plugged into. Dial the digital voltmeter to the 200 ~ setting.

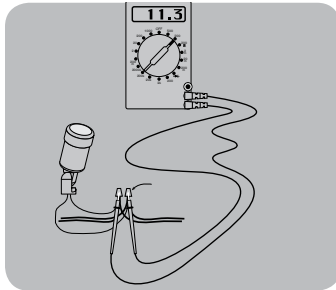

Checking voltage at fixtures
Insert voltmeter probes into each wire connector
(Optimum reading between 10.5 and 11.5 V)

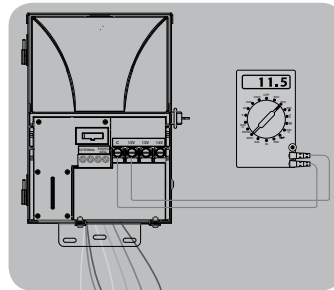

Checking voltage at lugs
(Each lug should read no more than +/- 0.3 to 0.9 volts of rated output)

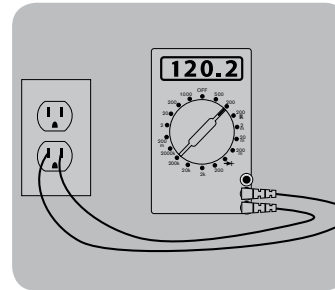

Checking voltage at plug
(Safe voltage reading between 117 and 125 V)

INSTALLATION TOOLS

THE AMP CLAMP

THE AMP CLAMP LIGHTING PROFESSIONAL'S TOOL OF CHOICE

The amp clamp is both a digital voltmeter and an amp probe combined. This tool can be used to check system voltage, amperage and continuity. It is a most valuable troubleshooting tool that can save you time and frustration. To test amperage on the fluke amp clamp, set the dial to \bar{A} . To test voltage with a fluke amp clamp, set the dial to $V\sim$. Set amp clamp to \bar{A} . Clamp all wires on each common. Clamp each wires on commons. Check cable specs to compare amp reading with safe loads.

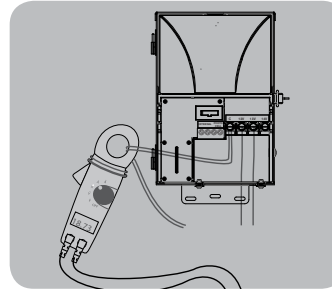

Checking Amperage at Transformer Commons

Set amp clamp to \bar{A} . Clamp all wires on each common. Maximum amp load per common is 15 amps for the LX-150 and 25 amps for the LX-300. If amp reading exceeded, there is either a short in the wiring or a wattage overload on one or more cables installed in the common being tested.

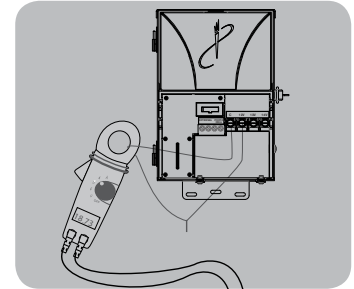

Testing Amperage on single cable

Set amp clamp to \bar{A} . Clamp each wires on commons. Check cable specs to compare amp reading with safe loads.

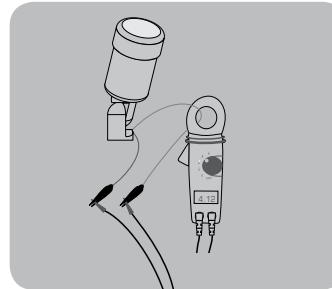

Testing Amperage at Fixtures

Set amp clamp to \bar{A} . Clamp only one wire lead. This reading will help you determine the wattage rating of the fixture's lamp.

- 0.8 reading (+/-) = 10 watt lamp
- 1.6 reading (+/-) = 20 watt lamp
- 2.9 reading (+/-) = 35 watt lamp
- 4.1 reading (+/-) = 50 watt lamp

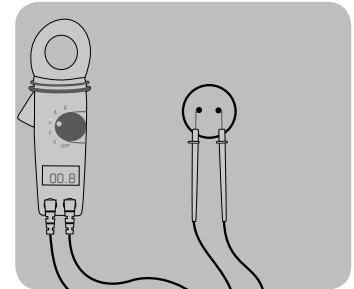

Testing Continuity

Place amp clamp on the Ω setting. Put probes on each side of conductor or lamp pins. If clamp tones or attempts to reach 0.000, there is a continuous circuit. Lamp/cable is good. If clamp does not tone and stays at 1.0 setting, there is a break in the line or lamp is no good.

INSTALLATION TOOLS

CIRCUIT OVERLOAD

If the amperage load on any given common lug exceeds the transformer capacity the circuit breaker will trip and the display will read "Err" (Error). Test the amperage load on all cables on the common lug using an amp clamp. Test each individual cable on the common lug with the amp clamp. To remedy an overload, either reduce the wattage of the lamps in the fixtures or rebalance the amp load between commons.

SHORT CIRCUIT

The LCD will read "Err" (for Error) and shut off power if there is a short somewhere in the cabling. This message will continue to be displayed until any button is pressed. To test for a short circuit, check each cable on the common tap that is tripping individually.

Example: A circuit with 100 watts of load (five 20 watt fixtures) should have an amp reading of approximately 8 amps. If the cable is reading significantly more, it has a short somewhere in the cable.

NOTE: Shorts and overloads are **NOT** covered by the FX warranty and can only be detected when the transformer is tested in the field.

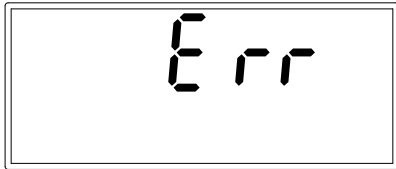

INTERNAL FUSE REPLACEMENT

If the unit does not power on when plugged into a working outlet the internal fuse may need to be replaced. To replace:

1. Unplug unit from incoming power as well as outgoing line to fixtures.
2. Remove the top core cover above the main control face pack.
3. Locate the black fuse cylinder and remove the original fuse.

Replace with a UL Listed 3AG with the following specifications:

10 Amp – 250V

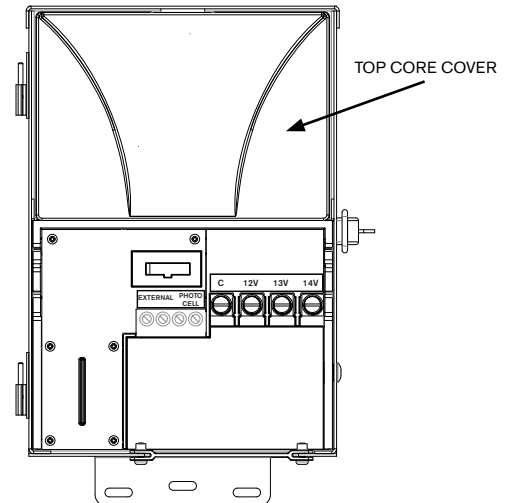

USING PROGRAMMING FUNCTIONS

SET SYSTEM TIME

This is the main system clock setting.

1. Begin by using the Mode Selector to initiate SET TIME function
2. First set AM or PM using the UP or DOWN arrow and initiate by pressing Select
3. Then select the hour using the UP or DOWN arrows and initiate by pressing Select
4. Next select the minutes using the UP or DOWN arrows and initiate by pressing Select
5. Last select the current day of the week and press select to initiate all settings

SET PROGRAM ON TIME

Programs are designated by a letter from A-F and must have an On Time with days of the week selected as well as an Off Time.

1. Begin by selecting the Program (A-F)
2. First set AM or PM using the UP or DOWN arrow and initiate by pressing Select
3. Then select the hour using the UP or DOWN arrows and initiate by pressing Select
4. Next select the minutes using the UP or DOWN arrows and initiate by pressing Select
5. Last select the days of the week that the program should run by highlighting the day and pressing the Up Button to add or Down button to remove from the program, and press select to initiate each day setting in sequential order.

SET PROGRAM OFF TIME

After choosing a Program letter and setting its On Time(s) the Off times must be set for the same program selected by pressing the Mode selector button to initiate the setting mode.

1. First set AM or PM using the UP or DOWN arrow and initiate by pressing Select
2. Then select the hour using the UP or DOWN arrows and initiate by pressing Select
3. Next select the minutes using the UP or DOWN arrows and initiate by pressing Select
4. Last select the days of the week that the program should run by highlighting the day and pressing the Up Button to add or Down button to remove from the program, and press select to initiate each day setting in sequential order.

MANUAL MODE

Manually turn lights on for a designated period.

1. Navigate to MANUAL using the MODE button – ENTER
2. HOUR will flash prompting a run-time entry
3. Choose hour using UP or DOWN Buttons – ENTER
4. MINUTE will flash
5. Choose minutes using UP or DOWN Buttons – ENTE
6. Lights will come on immediately and stay on for the time specified

USING PROGRAMMING FUNCTIONS

TURNING SYSTEM OFF

1. Navigate to the OFF setting using the MODE button and wait 3 seconds. The lights will turn off. If you leave the system in the OFF mode, they will stay off permanently. You can press the MODE button one additional time to return to AUTO mode.

USING PROGRAMMING FUNCTIONS

PROGRAMMING OFF TIME WITH A PHOTOCELL

When a Photocell is installed on the unit it can be used as the light shutoff or be bypassed to use the timer.

1. Navigate to OFF TIME using the MODE button
2. HOUR will flash
3. Choose hour using UP or DOWN Buttons – ENTER
4. Between 5AM and 6AM is the DAWN Setting. Press ENTER to use the Photocell instead of a time setting to sense dawn (high-light) to shut-off lights
5. OFF TIME is now set – MODE will return to AUTO

PROGRAMING ON TIME WITH A PHOTOCELL

When a Photocell is installed on the unit it can be used as the light initiator or be bypassed to use the timer.

1. Navigate to ON TIME using the MODE button
2. HOUR will Flash
3. Use the UP and DOWN button to navigate to the DUSK setting, which is between the hours of 5PM and 6PM. Press ENTER to use the Photocell instead of a time setting to sense dusk (low-light) to initiate the lights
4. ON TIME is now set to use Photocell DUSK Setting – MODE will return to AUTO

TURNING SYSTEM ON MANUALLY

Manually turn lights on for a designated period.

1. Navigate to MANUAL using the MODE button – ENTER
2. HOUR will flash prompting a run-time entry
3. Choose hour using UP or DOWN Buttons – ENTER
4. MINUTE will flash
5. Choose minutes using UP or DOWN Buttons – ENTER
6. Lights will come on immediately and stay on for the time you set

ALTERNATE METHOD FOR TURNING SYSTEM ON MANUALLY

If you enter the MANUAL function using the MODE button, and wish to change only the hour(s), or not make any changes, simply do not push any buttons for 3 seconds and the lights will come on.

INSTALLING MULTIPLE TRANSFORMERS

CONTROLLING A TRANSFORMER VIA AN EXTERNAL SOURCE

The LX Transformer can be controlled from another transformer via the 1–24 volt EXTERNAL connection.

Operate multiple transformers from a single source:

1. If you have multiple transformers on a single site, a PRIMARY transformer can be designated to trigger them all.
2. Select PRIMARY controller and ensure that the POWER IS OFF.
3. Run a wire from the common terminal and one of the three voltage taps from the PRIMARY TRANSFORMER.
4. Connect this from PRIMARY TRANSFORMER into the slave controller via the EXT (external) input.
5. At the SLAVE TRANSFORMER, be sure to set the ON TIME to "NONE" so that the unit only comes on due to the EXT input.

6. SLAVE TRANSFORMER is now ready to receive input from the PRIMARY TRANSFORMER.
7. To confirm connection, reestablish power to both PRIMARY and SLAVE transformers.
8. Activate lights via the PRIMARY TRANSFORMER.
9. A positive connection can be confirmed by the EXT light on the faceplate of the SLAVE TRANSFORMER(S) turning green.

The PRIMARY controls all lighting functions via its timing and/or control functions.

The SLAVE initiates when the PRIMARY starts its lighting function.

As long as the SLAVE transformer is receiving between 1–24 volts as many SLAVES can be connected as needed to a PRIMARY.

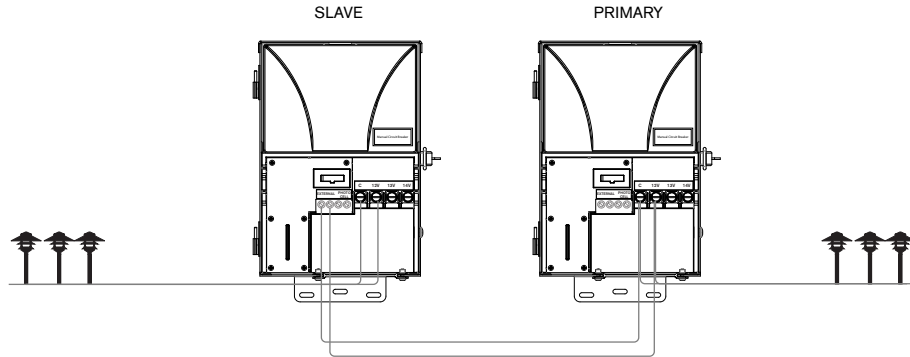

FREQUENTLY ASKED QUESTIONS

WHY AREN'T MY LIGHTS TURNING ON DURING THEIR SCHEDULED RUN TIME?

Have you recently turned your lights off using the OFF mode? If so, the unit is automatically assuming you wanted to cancel the entire lighting event for the day. To override this, you must momentarily change the unit's time of day to an hour that is outside of the lighting window. That way, the unit will assume a day has gone by. Then re-enter the correct time. Once you have done this, the lights should come on. Also, make sure that the AM/PM settings are correct for ON time, OFF time and Time of day.

I HAVE THE ON TIME SET FOR DUSK. WHEN I COVER THE PHOTOCELL, WHY DON'T MY LIGHTS COME ON?

To avoid having the lights go on and off numerous times at dusk and dawn, the unit utilizes various filters and delays regarding the photocell. It may take up to one minute for the lights to come on after the photocell is put in the dark. The same rule applies to exposing the photocell to light in order to turn the lights off.

Have you recently shut off a lighting cycle using the OFF mode? If so, the unit is automatically assuming you wanted to cancel the entire lighting event for the day. To override this, you must expose the photocell to light for at least one minute, and then allow it to be in darkness again. The lights should come on within one minute of the photocell returning to darkness.

HOW DO I RESTORE MY UNIT'S PROGRAMMING TO THE FACTORY DEFAULT VALUES?

Hold down the Select/Enter button + Down button on the facepack. Then, press the reset button on the back of the facepack. First, release the reset button, and then release the buttons on the front. If you've done this correctly, the time should say 12:00.

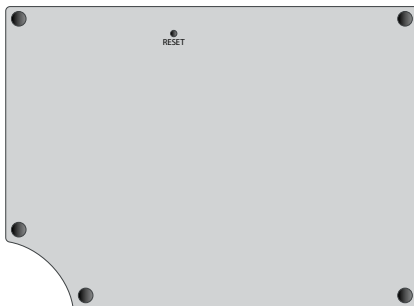

GLOSSARY

WORD	DEFINITION
Amp	Unit of measure of electrical flow through wire or other conduit; the volume of current; the number of electrons flowing past a given point per second; analogous to GPM
Circuit	The path of electrical current from power source through cable to fixtures and back to the source
Circuit Breakers	A safety device that opens (shuts down the flow of electricity) a circuit when a short or overload occurs. Line voltage circuit breakers found in the house electrical panel used on circuits for low voltage lighting systems are typically rated for either 15 or 20 amps. Low voltage circuit breakers found in UL 1838 compliant transformers have a load capacity of 25 amps.
Continuity	An uninterrupted electrical path
Load	Total amperage or wattage on a circuit
Overload	Current demand exceeding that which the cable or circuit breaker was designed
Run	Distance of cable from the transformer to fixtures
Short Circuit	Improper connection between hot wires or between a hot wire and a neutral wire
Voltage	A measure of electrical force or pressure; that which causes electrical current to flow through cable; analogous to PSI
Voltage Drop	The loss of electrical pressure
Watts	A unit of measure of electrical power or consumption

TROUBLESHOOTING

PROBLEM	CAUSE	SOLUTION
No power at plug	Tripped breaker or GFCI	Reset circuit breaker in main panel or the GFCI usually located in a bathroom, garage, or kitchen.
GFCI keeps tripping	Ground problem or defective GFCI	Use a high-grade model such as the Hubbell #GF5252L.
One cable run not working	Cut cable or short	Test cable for voltage. If none, it is cut. If there is very low voltage and the cable is hot, there is a short. Check all fixtures and splices for defects.
Lamps are burning out prematurely	Excessive voltage at lamp	Drop the affected cable run down to the next lower voltage tap or increase wattage load on that cable to drop voltage. Also, some lamps are rated for a very short life such as the 4414 (300 hours). Use halogen lamps.
The closest lamp to the transformer is burning out prematurely	Excessive voltage at lamp	The closest lamp will always have a higher voltage reading than the last lamp. Cable fixtures so that there is about 40' from first to last within a lighting zone. See system layout for details.
Lamps have a yellow or golden tone	Voltage too low	Move affected cable to the next higher voltage tap or reduce load on cable. If possible, run additional cable to first fixture to reduce voltage loss.
Lamp goes on and off when fixture is moved	Too much tension on socket leads	With spring type sockets, it is important to leave some slack so the socket contacts make a good connection to the lamp base.
System is getting dimmer with age	Splices are corroding	As non-waterproof splices corrode, they create electrical resistance, which reduces voltage.
Photocell transformer is coming on too soon	Transformer is in dark location	In order to operate properly, the photocell must have a good look at daylight. Move to a brighter location.
Fixtures have a white mineral deposit on them	Irrigation water is hitting them	Schedule the irrigation to come on after the lights have gone off. This is especially true with the 50 W spots – very hot.

IMPORTANT NOTES

NOTE: Not for use with dimmers.

CAUTION:

FOR USE ONLY ON A BRANCH CIRCUIT PROTECTED BY A CLASS A TYPE GROUND FAULT CIRCUIT INTERRUPTER.

FOR USE WITH LANDSCAPE LIGHTING SYSTEMS ONLY.

THIS DEVICE IS ACCEPTED AS A COMPONENT OF A LANDSCAPE LIGHTING SYSTEM WHERE THE SUITABILITY OF THE COMBINATION SHALL BE DETERMINED BY CSA OR LOCAL INSPECTION AUTHORITIES HAVING JURISDICTION.

LANDSCAPE LIGHTING SYSTEMS ARE FOR OUTDOOR USE ONLY.

NOT FOR USE IN DWELLING UNITS.

POWER SUPPLIES ARE FOR OUTDOOR USE ONLY.

DO NOT MOUNT POWER SUPPLY OR LUMINAIRES WITHIN 3 METERS OF A SWIMMING POOL OR SPA.

A CORD-CONNECT LANDSCAPE LIGHTING SYSTEM SHALL NOT BE USED WITH AN EXTENSION CORD.

WARRANTY

FX LUMINAIRE TRANSFORMER WARRANTY POLICY AND PROCEDURE

FX Luminaire warrants its transformers from manufacturer's defects for a period of 10 years from the date of installation. If an FX Transformer should fail due to manufacturing defects within this period, FX Luminaire will repair or replace the faulty unit free of charge.

If you suspect that your FX Transformer has failed due to a manufacturer's defect, contact FX Technical Services at 1-800-733-2823 for assistance and warranty procedure. Do not remove the transformer until you have contacted Technical Services. Many problems can be solved over the telephone without having to remove the transformer from the premises.

TO PROPERLY ASSIST YOU WITH YOUR WARRANTY INQUIRY, TECHNICAL SERVICES WILL WANT TO KNOW THE FOLLOWING INFORMATION:

- The model number of the transformer
- Transformer switching options (timer, photocell, timer, and photocell, etc)
- Date of installation
- Who installed the transformer (if known)
- A description of the nature of the problem
- Has there been any recent change to the lighting system? For instance, were new lamps recently installed? Were additional fixtures added to the system? Have there been lightning storms or heavy rains?

WHAT'S EXCLUDED FROM THE FX TRANSFORMER WARRANTY:

- Insignificant defects such as scratches, minor mechanical or electrical maladjustments, or any manufacturing error that can be easily corrected
- Improper installation methods that cause or contribute to the failure of an FX product
- Lamps (bulbs) are not warranted

For additional technical support, please visit www.fx.com and refer to the Learning Center link or call our Technical Services Department at 1-800-733-2823.

FXLuminaire®

TECH LINE 1-800-733-2823 WEBSITE www.fx.com

© 2012 FX Luminaire. All rights reserved. Reproduction in any form of this material beyond that of assisting in the specification of FX Luminaire products is unlawful as per the United States Copyright Act of 1976. This publication is distributed with the understanding that the publisher is not engaged in rendering legal, architectural, accounting or other professional services. If legal advice or expert assistance is required the services of the appropriate professional person should be sought.